

# BORA

NEW!

## Zanzariera a scorrimento laterale

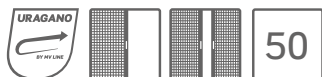

BORA

**Scorrimento:** laterale, si arresta manualmente in qualsiasi punto. Configurabile con una o più ante (fino a quattro)

**Avvolgimento:** a molla

**Sistema di apertura:** a magnete

**Sistema di attacco:** a baionetta

**Adatta per:** portafinestra

**Bottoncino:** no

**Rete:** rete nera **STRONG** di serie

**Viene fornita:** su misura

**Note:** adatta per porte-finestre fino a 180 cm di larghezza, guida bassa dallo spessore di soli 2 mm.

Elevata tenuta della rete al vento forte, grazie ad un sistema brevettato che ne ostacola la fuoriuscita.

### BORA

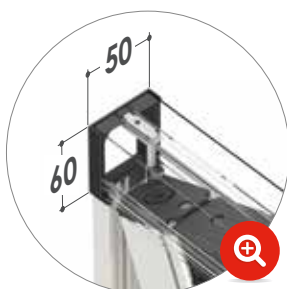

Innesto a baionetta



La guida a pavimento ha uno spessore di appena 2 millimetri.

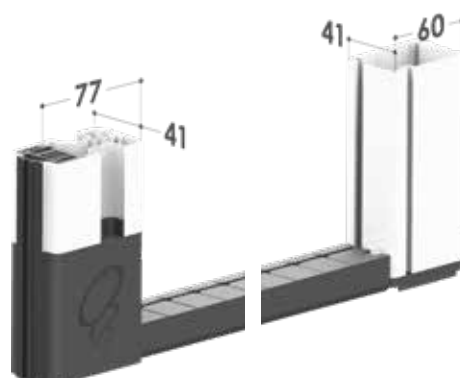
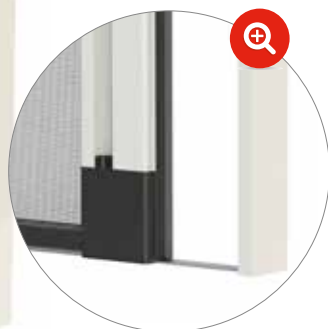

## SCHEMI DI ACCOPPIAMENTO DELLE ANTE

ANTA SINGOLA



ANTA DOPPIA CON APERTURA BILATERALE

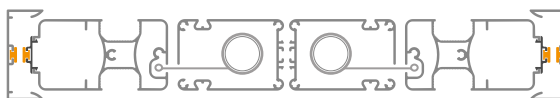

ANTA DOPPIA CON CHIUSURA AL CENTRO

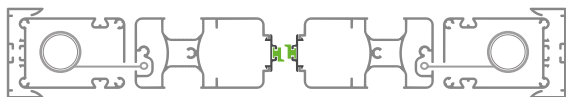

ANTA DOPPIA A SEGUIRE

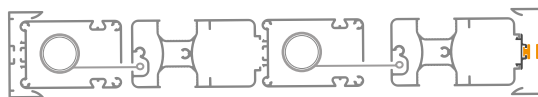

ANTA TRIPLA A SEGUIRE

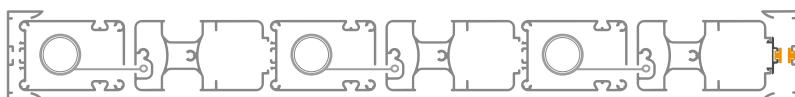

ANTA QUADRUPLA

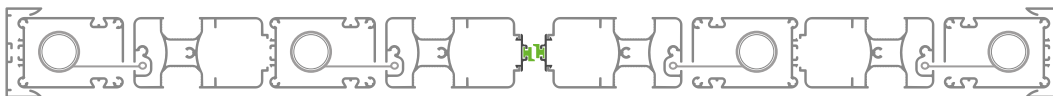

MAGNETE DIS. 43



MAGNETE DIS. 7



## MISURE CONSIGLIATE (mm)

Per anta	Larghezza (min/max)	Altezza (min/max)
Rete nera <b>STRONG</b>	- / 1800	1500 / 2500
Rete fibra	- / 2000	1500 / 2500

L'altezza deve essere superiore alla larghezza di almeno 200 mm.

**Per necessità di prodotti dalle dimensioni prossime ai limiti consigliati, si prega di contattare l'azienda prima di sottoporre un ordine.**

## COME ORDINARE

Formulare l'ordine indicando sempre la tipologia di misura, tenendo presente quanto segue:

- **misura LUCE**, la zanzariera verrà fornita 3 mm in meno rispetto alla misura del vano.
- **misura FINITA**, la zanzariera verrà fornita con le stesse misure ordinate.

## ACCESSORI

SE= DI SERIE / OP=OPZIONALE

### MODELLO

**STRONG** **SUNOX**

BORA	SE	OP
------	----	----

## TINTE DISPONIBILI

### RAL

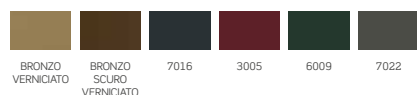

### OSSIDATI

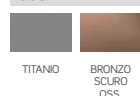

### SABLÈ

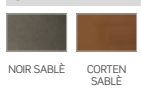

### RAFFAELLO

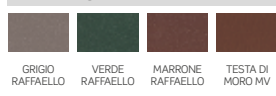

### SOFT

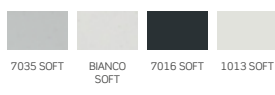
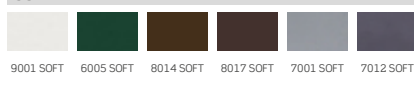

### LEGNO

